

NUMBER	NAME	MATERIAL	CODE	FINISH	QUANTITY	REMARKS
--------	------	----------	------	--------	----------	---------

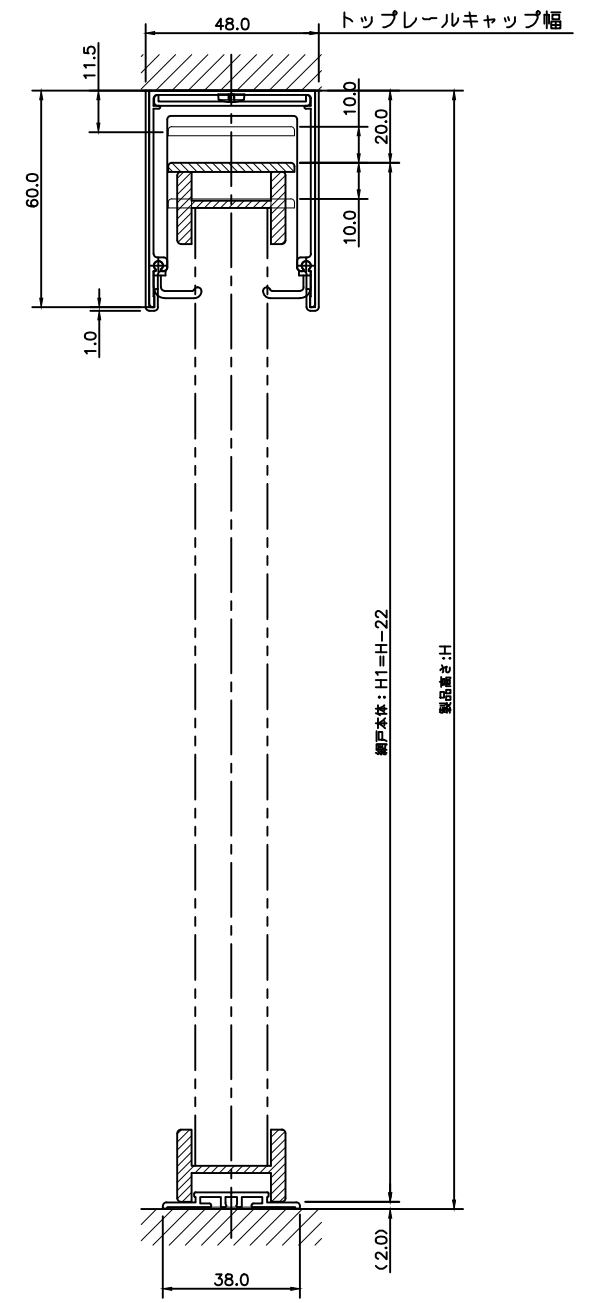
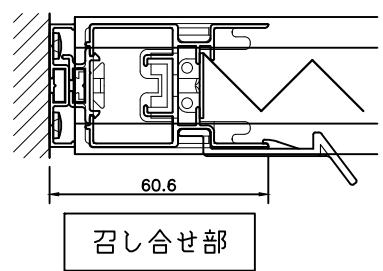
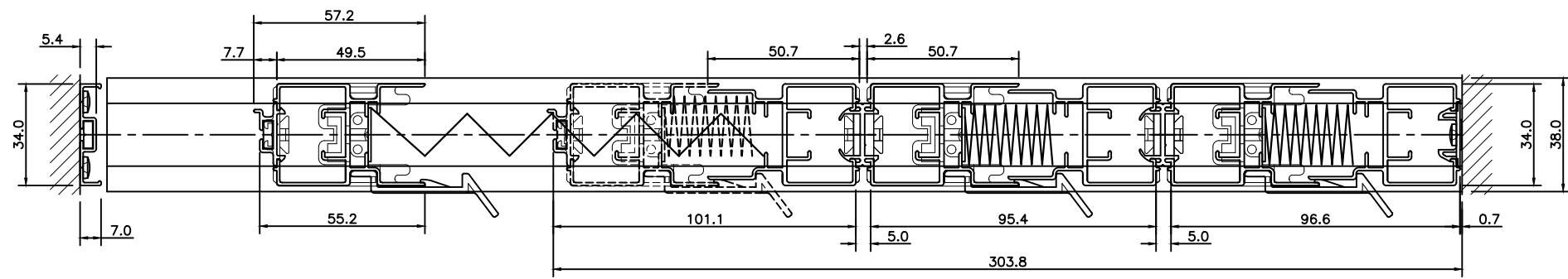

METACO inc.
 203 Nagatani Hill Plaza Roppongi, 7-3-8 Roppongi, Minato-ku, Tokyo, 106-0032 Japan
 TEL 03-3403-9571 FAX 03-3403-6498

TITLE タンデム 片引き (3枚建て仕様)
 SCS 88L-MT03
 SCALE A1 1/1 03

SALES
 DRAWING SASAKI
 CHECK
 DATE .
 DATE 2019.08.07
 NO. .

検印 検印